



## Sidekick Personal Storage

Sidekick solves the storage needs of hot-desking in any office work environment.

Providing maximum storage within a minimum floor space, Sidekick can be personalized with storage accessories unique to each person or task. Loads of accessories ensure Sidekick is functional and practical in any office.

<b>Manufacturer</b>	Planex Sales Pty Ltd
<b>Location</b>	Hallam, Melbourne
<b>Standard Warranty</b>	Ten years

#### Sidekick Dimensions

Code	Height	Width	Depth
28-SK-BY	1125	462	578

\*28-SK-BYN with name plate

#### Materials

- Welded body made of 100% recyclable BlueScope steel (with up to 20% recycled content)
- Polypropylene door

#### Colours/Finishes

- Standard powder coats available in 150+ colours/finishes
- Polypropylene (PP) tambour doors available in white, black, silver, grey, post grey, charcoal, beige, silver and translucent

#### Product Features

- Coat hook
- 80mm European twin wheel lockable castors
- European locking system with interchangeable barrel locks (1000 random combinations)
- No assembly required

#### Accessories Ordered Separately

- Adjustable shelves
- Shelf dividers
- Pull-out reference shelves
- Pull-out file frames (for drawer files)
- Rails to hold L'Oblique TUB folders (hook folders)
- Shelf wire rack dividers for lateral shelf files (wrap around and square)
- Magazine rack
- Paper tray
- Handle
- Drawer
- Lockable drawer top
- Master key and option to key-alike available

#### Manufacturing

- Made in Melbourne, Australia using locally sourced materials
- Manufactured for disassembly
- Polymer parts labelled for segregation and sorting
- Iron phosphate pre-treatment AS2331.3.1-2001 Method 3.1
- Planex factory uses a 100Kw roof mounted solar array to provide up to 25% of manufacturing electricity needs

#### Environmental Certification

- Product may contribute to Green Star credit points
- Production facility certified ISO14001 and ISO9001
- VOC compliant materials

Designed by Planex

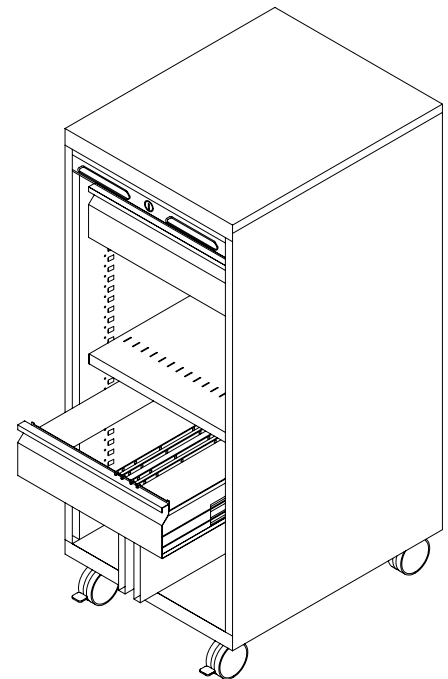
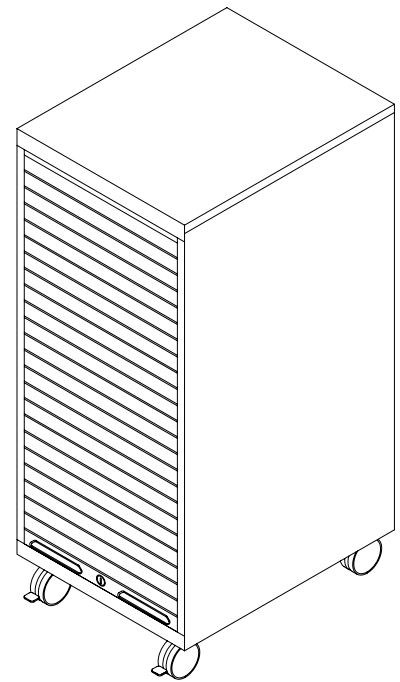

Sidekick Accessories

Adjustable Shelf	Height	Width	Depth
28-SK-SHU25	25	418	500
Shelf Divider	Height	Width	Depth
22-SHU-DIV150	150	1	383
Pull-Out File Frame	Height	Width	Depth
28-SK-PO	125	415	485
Rear Stop	Height	Width	Depth
28-SK-SHU-RS	40	415	47
Magazine Rack	Height	Width	Depth
28-SK-FOn/a	275	115	230
Paper Tray A4	Height	Width	Depth
28-SK-TR	50/40	315	220
Handle	Height	Width	Depth
28-SK-HANDLE	160	370	30
Drawer	Height	Width	Depth
28-SK-DR-PL	125/100	390	445
Coat Hook	Height	Width	Depth
n/a	20	20	36

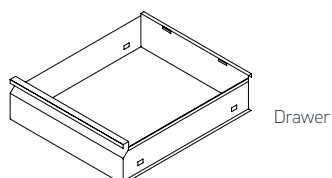
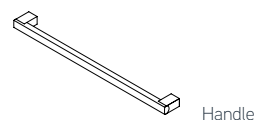
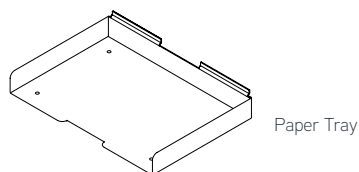
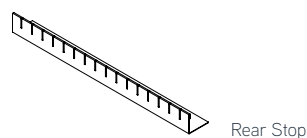
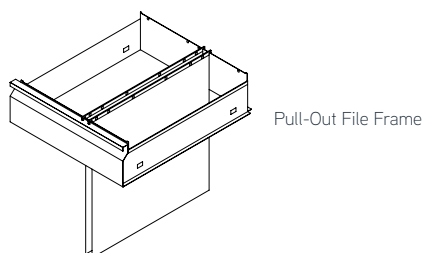
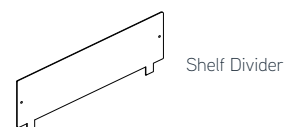
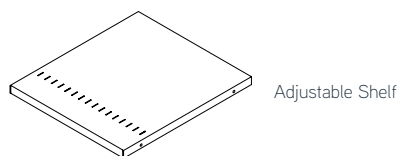

Copyright Planex 2018  
Information in this document may be  
subject to change without notification

**Head Office / Manufacturing**

191 Princes Highway, Hallam  
VIC Australia 3803  
PO Box 125 Hallam 3803  
Tel: +61 3 8795 1100  
Fax: +61 3 8795 1122  
Email Head Office: [info@planex.com.au](mailto:info@planex.com.au)

**Sydney Showroom**

(Mon - Fri, 9am - 5pm by appointment only)  
Studio 4, Level 2  
18-20 Victoria Street, Erskineville  
NSW 2043  
Tel: +61 2 9517 2411  
Fax: +61 2 9517 2544  
Email Sydney: [info@planex.com.au](mailto:info@planex.com.au)

**Adelaide Showroom**

(Mon - Fri, 9am - 5pm by appointment only)  
238 Grenfell Street, Adelaide  
SA 5000  
Tel: +61 3 8795 1100  
Email Adelaide: [info@planex.com.au](mailto:info@planex.com.au)

**Perth**

Tel: +61 3 8795 1100  
Email Perth: [info@planex.com.au](mailto:info@planex.com.au)

**Brisbane**

Tel: +61 3 8795 1100  
Email Brisbane: [info@planex.com.au](mailto:info@planex.com.au)

**Tasmania**

Tel: +61 3 8795 1100  
Email Tasmania: [info@planex.com.au](mailto:info@planex.com.au)

**ACT**

Tel: +61 3 8795 1100  
Email ACT: [info@planex.com.au](mailto:info@planex.com.au)