



Sidekick Personal Storage

Sidekick solves the storage needs of hot-desking in any office work environment.

Providing maximum storage within a minimum floor space, Sidekick can be personalized with storage accessories unique to each person or task. Loads of accessories ensure Sidekick is functional and practical in any office.

Manufacturer	Planex Sales Pty Ltd
Location	Hallam, Melbourne
Standard Warranty	Ten years

Sidekick Dimensions

Code	Height	Width	Depth
28-SK-BY	1125	462	578

*28-SK-BYN with name plate

Materials

- Welded body made of 100% recyclable BlueScope sheet steel (with 24.2% recycled content)
- Polypropylene door

Colours/Finishes

- Standard powder coats available in 300+ colours/finishes
- Polypropylene (PP) tambour doors available in white and translucent. Silver grey, bright silver (metallic), post grey, charcoal and black available on application

Product Features

- Coat hook
- 80mm European twin wheel lockable castors
- European locking system with interchange barrel locks (1000 random combinations)
- No assembly required

Accessories Ordered Separately

- Adjustable shelves
- Shelf dividers
- Pull-out reference shelves
- Pull-out file frames (for drawer files)
- Rails to hold L'Oblique TUB folders (hook folders)
- Shelf wire rack dividers for lateral shelf files (wrap around and square)
- Magazine rack
- Paper tray
- Handle
- Drawer
- Lockable drawer top
- Master key and option to key-alike available

Manufacturing

- Made in Melbourne, Australia using locally sourced materials
- Manufactured for disassembly
- Polymer parts labelled for segregation and sorting
- Iron phosphate pre-treatment AS2331.3.1-2001 Method 3.1
- Planex factory uses a 100Kw roof mounted solar array to provide up to 25% of manufacturing electricity needs

Environmental Certification

- Product may contribute to Green Star credit points
- Production facility certified ISO14001 and ISO9001
- VOC compliant materials

Designed by Planex

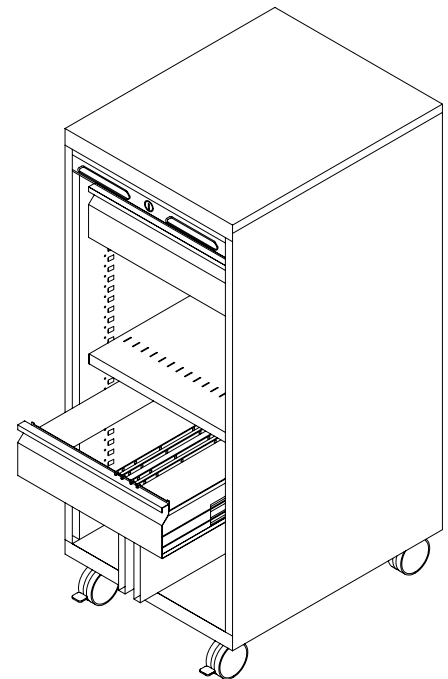
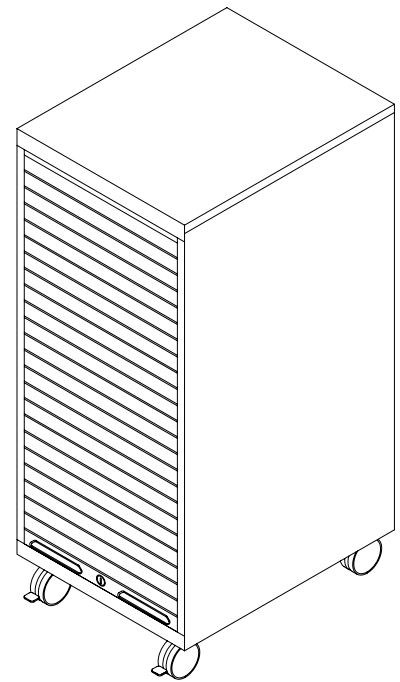

Sidekick Accessories

Adjustable Shelf	Height	Width	Depth
28-SK-SHU25	25	418	500

Shelf Divider	Height	Width	Depth
22-SHU-DIV150	150	1	383

Pull-Out File Frame	Height	Width	Depth
28-SK-PO	125	415	485

Rear Stop	Height	Width	Depth
28-SK-SHU-RS	40	415	47

Magazine Rack	Height	Width	Depth
28-SK-FOn/a	275	115	230

Paper Tray A4	Height	Width	Depth
28-SK-TR	50/40	315	220

Handle	Height	Width	Depth
28-SK-HANDLE	160	370	30

Drawer	Height	Width	Depth
28-SK-DR-PL	125/100	390	445

Coat Hook	Height	Width	Depth
n/a	20	20	36

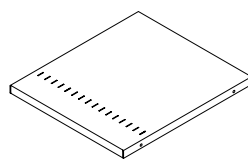

Adjustable Shelf

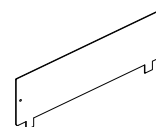

Shelf Divider

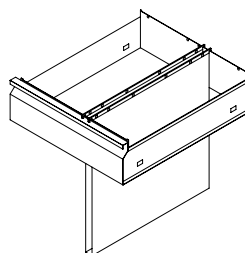

Pull-Out File Frame

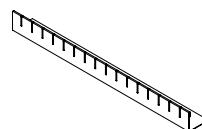

Rear Stop

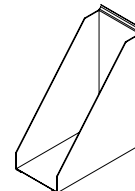

Magazine Rack

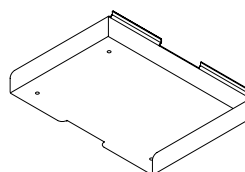

Paper Tray

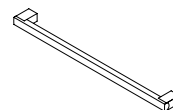

Handle

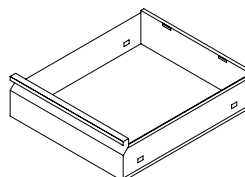

Drawer



Coat Rail



Copyright Planex 2022

Information in this document may be
subject to change without notification

Head Office / Manufacturing

191 Princes Highway Hallam

VIC Australia 3803

PO Box 125 Hallam 3803

Tel: +61 3 8795 1100

Fax: +61 3 8795 1122

Email Head Office: info@planex.com.au

National Sales and Distribution

Adelaide

Brisbane

Canberra

Hobart

Perth

Sydney

Tel: +61 3 8795 1100

Email: info@planex.com.au

www.planex.com.au